



Led High Bay Retrofit Series



Specifications

Model	DHBR-40LED/4K EX39 100-277V
Rated Wattage	40W
Input Voltage	100-277VAC 50/60Hz
CCT	4000K
Power Factor	≥ 0.9
CRI	80
Lumen	5000lm
Brand	Damar
LED LM80	Yes

Dimensions

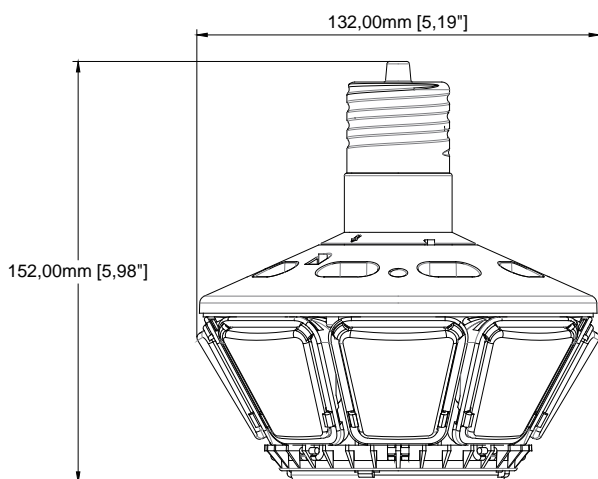

Photometric Data

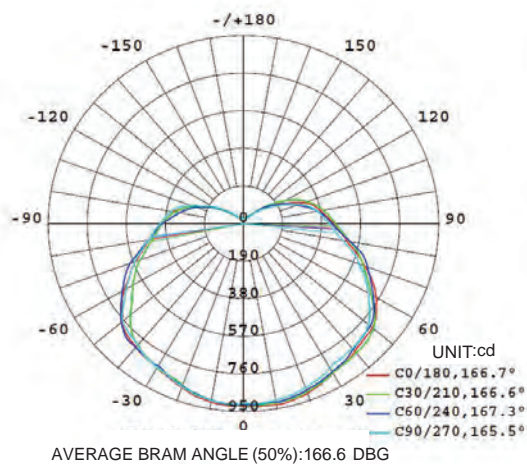

- Long Life**
10 years
OK
Long Lifespan of 10years
- Reliability**
ON OFF
x 1,000,000
OK
Reliability Test
- Auto Safety**
OK
Safety Protection Circuit
- Hg · UV**
OK
No Mercury
No UVLight
- Electricity Fee**
OK
Big Saving(87%)
on Electricity Costs