

LED SHOE BOX LIGHT

Installation Guide

Cautions:

1. Can not use the electric generator to test the LED lamp.
2. Please abide by related country, regional and local law and regulations when install this fixture.
3. To avoid electrical shock and damage, please do not install the lights in raining days.

Notices:

1. To prevent from electric shock or fire risk, the installation must be conducted by operator who has professional electrical knowledge.
2. Please wear gloves to avoid injury before installing lamps.
3. During or after installation, if there are situations such as smoke, fire in the wires or lamps, please turn off the power immediately and notify relevant personnel of an overhaul.
4. This light can be used for outdoor installation.

Instructions:

1. This product has dimming and non-dimming function, which differs in installation ways.
2. 3 dimming functions are available in this LED lamp:
 - (1). Constant current can be achieved by 1-10V DC dimming.
 - (2). PWM signal dimming.
 - (3). Variation of resistance unit dimming (Please choose the appropriate dimming way according to your needs. You can also choose not to use this function).
3. Choose the wire connection ways, dimming ways and installation ways according to your needs and the LED fixture purchased.

Wiring Diagram:

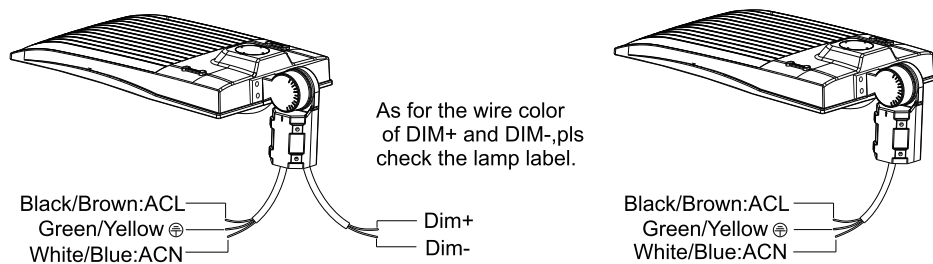

Optional Mountings and Installation Instructions

There are 4 optional mountings for this fixture. The following is LED lamp fixture with different mountings.

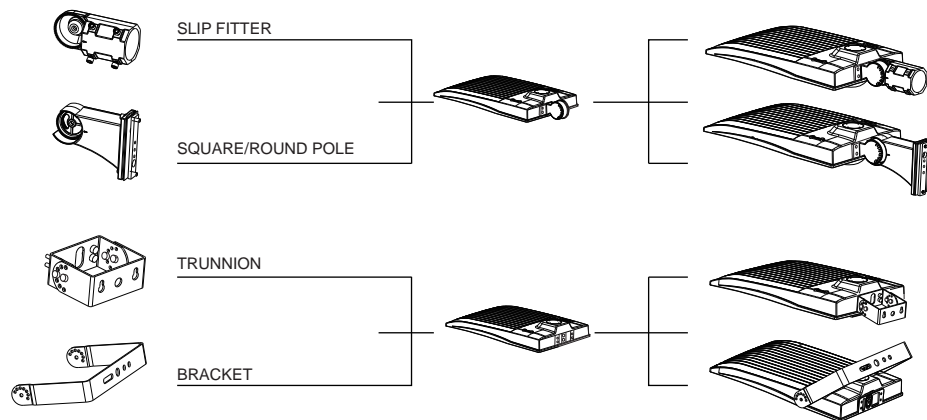

Installation Instructions with different mountings:

1. SLIP FITTER MOUNTING

- Step 1: Remove the mounting screws on the fixture and run the wires through the mounting. (Figure 1)
- Step 2: Install the mounting on the fixture. (Figure 2)

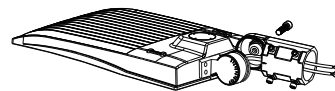

Figure 1

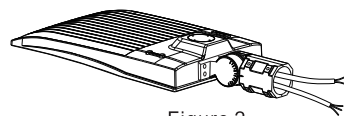

Figure 2

2. SQUARE/ROUND POLE MOUNTING

- Step 1: Remove the mounting screws on the fixture, open the side lid of mounting and run the wires through the mounting. (Figure 3)
- Step 2: Install the mounting on the fixture, then cover the side lid and tighten it. (Figure 4)

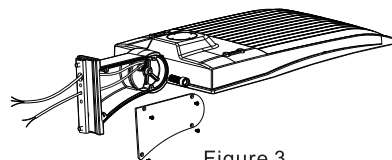

Figure 3

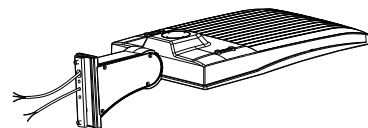

Figure 4

3. TRUNNION MOUNTING

- Step 1: Remove the mounting screws on the fixture and run the wires through the mounting. (Figure 5)
- Step 2: Install the mounting on the fixture. (Figure 6)

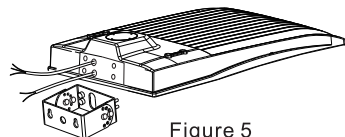

Figure 5

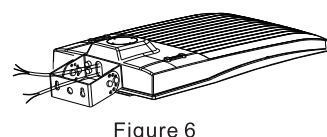

Figure 6

4. BRACKET MOUNTING

- Step 1: First install two big screws. (Figure 7)
- Step 2: Install two small screws. (Figure 8)

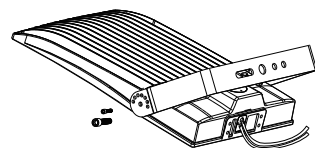

Figure 7

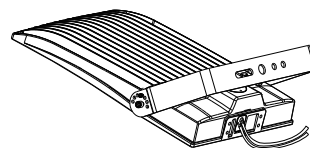

Figure 8

Installation of LED Lamps:

1. SLIP FITTER MOUNTING

- Step 1: Loosen the four bolts on the mounting, connect the wires correctly, and pull the wires into the poles. (Figure 9)
- Step 2: Place the mounting into the pole and lock the four bolts. (Figure 10)

Notice: Adjustable angle is 0-90° (Figure 9)

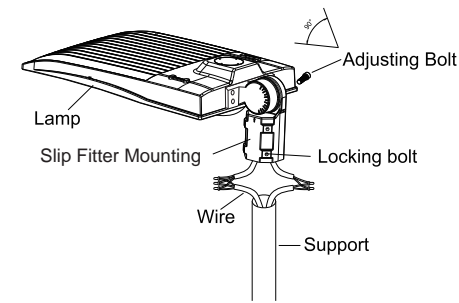

Figure 9

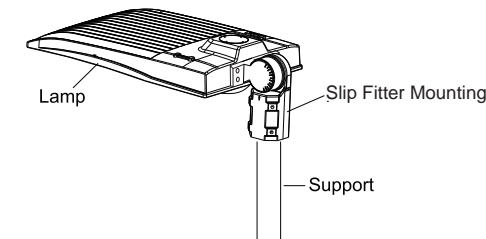

Figure 10

2. SQUARE/ROUND POLE MOUNTING

- Step 1: Fix the mounting to the pole with bolt, open the side lid of the mounting, pull the wire into junction box, and connect the wire correctly. (Figure 11)
- Step 2: Put the connected wire into the junction box, then cover the junction box. (Figure 12)

Notice: Adjustable angle is 0-35° (Figure 11).

Same as round pole installation, please remember to remove the silicon plate when install the fixture in round pole (Figure 13)

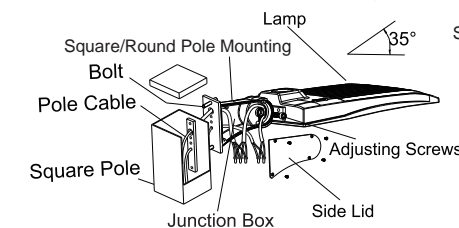

Figure 11

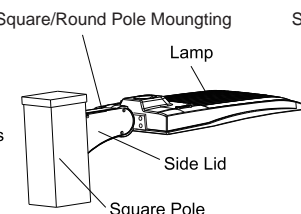

Figure 12

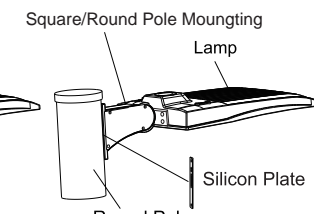

Figure 13

3. TRUNNION MOUNTING

Step 1: Drill holes on the wall as shown. (Figure 14)
Step 2: Knock the expansion bolts into the wall. (Figure 15)
Step 3: Connect the fixture to the mounting and tighten the screws; connect the wires properly and put them into junction box. (Figure 16)
Notice: Adjustable angle is 0-90° (Figure 16)

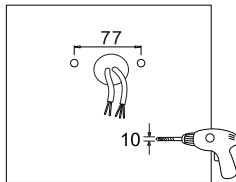

Figure 14

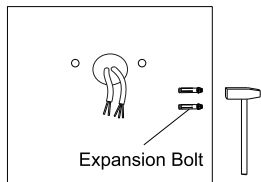

Figure 15

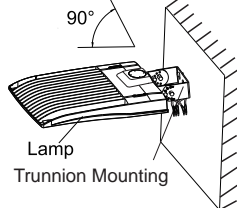
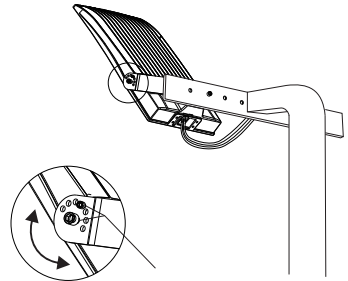
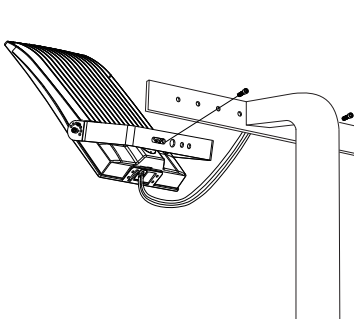

Figure 16

4. BRACKET MOUNTING

Install the mount to the fixture, tighten the mount and install the screws.



Loosen the angle to adjust the screw, after adjust to the angle that you need, then tighten the screws.

Standard wire:
L/live wire: Black\Brown;
N/null wire: White\Blue;
Ground wire: Green\Yellow-green.

MIN 75 °C SUPPLY CONDUCTOR
THIS PRODUCT MUST BE INSTALLED IN ACCORDANCE WITH THE APPLICABLE INSTALLATION CODE BY A PERSON FAMILIAR WITH THE CONSTRUCTION AND OPERATION OF THE PRODUCT AND THE HAZARDS INVOLVED.

LES FILS D'ALIMENTATION 75 °C MIN
CE PRODUIT DOIT ÊTRE INSTALLÉ SELON LE CODE D'INSTALLATION PERTINENT, PAR UNE PERSONNE QUI CONNAÎT BIEN LE PRODUIT ET SON FONCTIONNEMENT AINSI QUE LES RISQUES INHÉRENTS.

Instructions for Photocell

When the photocell function is required, photocell should be installed on the back of lamp; When it's not required, shorting cap should be installed on the back of lamp

