

# INSTRUCTION MANUAL

## Dual-mode T8 LED Tube

Please keep this Quick Installation Guide for future reference. Modifications to the product void the Warranty. Suitable to replace fluorescent lamps as specified on the product label.

### TYPE A

Assembly introduction:

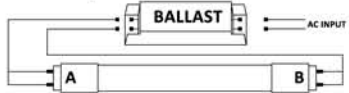

Installation Guide:

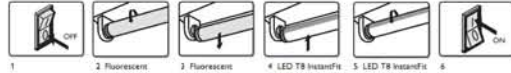

Instructions:

1. Switch-off power to the luminaire.
2. Remove diffuser ( if provided).
3. Remove the existing fluorescent lamps from the luminaire.
4. Install the LED tube lamp.
5. Install diffuser (if removed in step 2)
6. Switch on power to the luminaire.
7. Before installation, please check specifications for the most current ballast compatibility list, if no match, please insert led tubes according to below type B installation instructions.

### TYPE B

Assembly introduction:

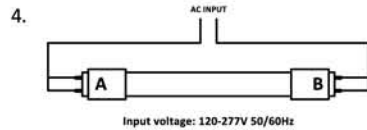
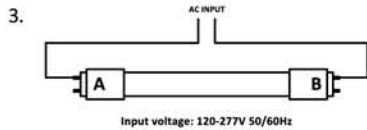
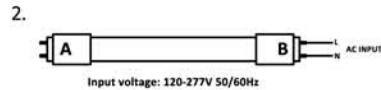
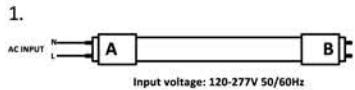

Note: the tube can work with either one side power input or double side power input

Installation Guide:

Instructions:

#### 1. DISCONNECT POWER OF LUMINAIRE

Disconnect power to luminaire or circuit (if possible). Ensure all power is off by using a voltmeter or other method to confirm.

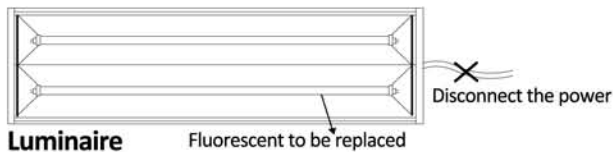

#### 2. REMOVE EXISTING TUBE LAMP(S)

- a. Remove troffer lens, if present.
- b. Remove existing fluorescent by rotating one quarter turn and sliding lamp(s).
- c. Remove ballast cover. (Cover may be secured with screws or tabs)

### 3. RETROFIT LUMINAIRE

#### a. Retrofit luminaire with inductive ballast

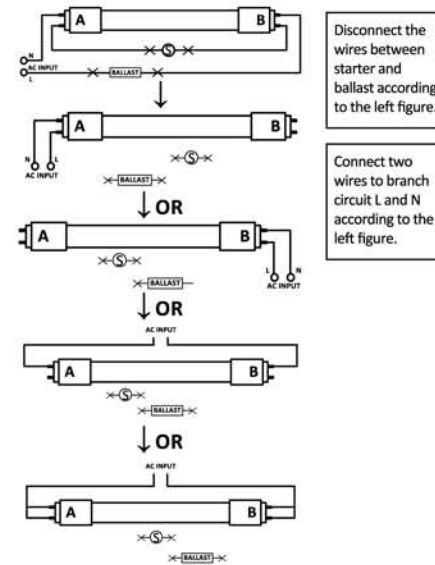

#### b. Retrofit luminaire with electronic ballast

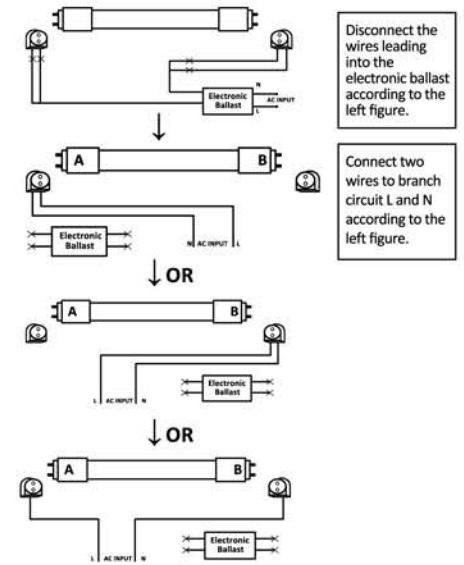

#### c. Retrofit luminaire with two lamps and one electronic ballast

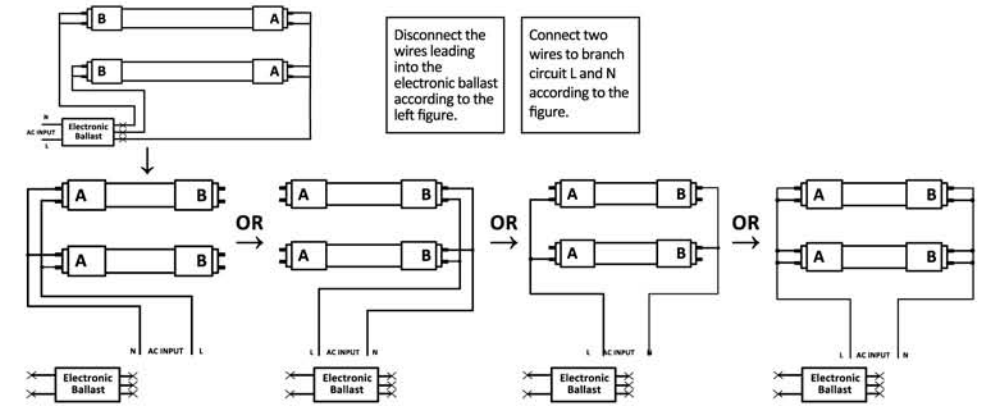

#### MARKINGS/ INSTALLATION INSTRUCTION /WARNING:

- a. Risk of fire or electric shock. LED Retrofit Kit installation requires knowledge of luminaires electrical systems. If not qualified, do not attempt installation. Contact a qualified electrician.
- b. Risk of fire or electric shock. Install this kit only in the luminaires that have the construction features and dimensions shown in the photographs and/or drawings and where the input rating of the retrofit kit does not exceed the input rating of the luminaire.
- c. Do not make or alter any open holes in an enclosure of wiring or electrical components during kit installation.
- d. To prevent wiring damage or abrasion, do not expose wiring to edges of sheet metal or other sharp objects.
- e. To avoid potential fire or shock hazard, do not use this retrofit kit in luminaires employing shunted bi-pin lampholders. Note: Shunted lamp holders are found only in fluorescent luminaires with Instant-Start ballasts. Instant-start ballasts can be identified by the words "Instant Start" or "I.S." marked on the ballast. This designation may be in the form of a statement pertaining to the ballast itself, or may be combined with the marking for the lamps with which the ballast is intended to be used, for example F40T12/IS. For more information, contact the LED luminaire retrofit kit manufacturer.
- f. Installers should not disconnect existing wires from lampholder terminals to make new connections at lampholder terminals. Instead installers should cut existing lampholder leads away from the lampholder and make new electrical connections to lampholder lead wires by employing applicable connectors.
- g. For a linear tubular LED lamp conversion, there shall be text or a diagram showing how the supply connections were made to the lampholders so the correct connections will be made to the lamp when the lamp is installed or replaced.
- h. This retrofit kit is accepted as a component of a luminaire where the suitability of the combination shall be determined by authorities having JURISDICTION.